

100V, 20A, 36mΩ N-channel Power Trench MOSFET

JMTK500N10A

Features

- Excellent $R_{DS(ON)}$ and Low Gate Charge
- 100% UIS Tested
- 100% ΔV_{ds} Tested
- Halogen-free; RoHS-compliant

Applications

- Load Switch
- PWM Application
- Power Management

Product Summary

Parameters	Value	Unit
V_{DSS}	100	V
$V_{GS(th_Typ)}$	1.5	V
$I_D(@V_{GS}=10V)$	20	A
$R_{DS(ON_Typ)}(@V_{GS}=10V)$	34	mΩ
$R_{DS(ON_Typ)}(@V_{GS}=4.5V)$	36	mΩ

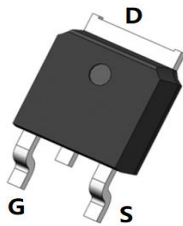

TO-252-3L Top View

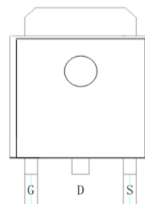

Pin Assignment

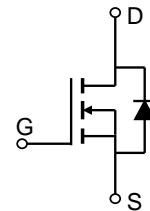

Schematic Diagram

Ordering Information

Device	Marking	MSL	Form	Package	Reel(pcs)	Per Carton (pcs)
JMTK500N10A	JMTK500N10A	3	Tape&Reel	TO-252-3L	2500	25000

Absolute Maximum Ratings (@ $T_C = 25^\circ\text{C}$ unless otherwise specified)

Symbol	Parameter	Value	Unit
V_{DS}	Drain-to-Source Voltage	100	V
V_{GS}	Gate-to-Source Voltage	± 20	V
I_D	Continuous Drain Current	$T_C = 25^\circ\text{C}$	20
		$T_C = 100^\circ\text{C}$	13
I_{DM}	Pulsed Drain Current ⁽¹⁾	Refer to Fig.4	A
E_{AS}	Single Pulsed Avalanche Energy ⁽²⁾	31	mJ
P_D	Power Dissipation	$T_C = 25^\circ\text{C}$	40
		$T_C = 100^\circ\text{C}$	16
T_J, T_{STG}	Junction & Storage Temperature Range	-55 to 150	$^\circ\text{C}$

Thermal Characteristics

Symbol	Parameter	Max	Unit
$R_{\theta JA}$	Thermal Resistance, Junction to Ambient ⁽³⁾	37	$^\circ\text{C}/\text{W}$
$R_{\theta JC}$	Thermal Resistance, Junction to Case	3.1	

**Electrical Characteristics** ($T_J = 25^\circ\text{C}$ unless otherwise specified)

Symbol	Parameter	Conditions	Min.	Typ.	Max.	Unit
Off Characteristics						
$V_{(BR)DSS}$	Drain-Source Breakdown Voltage	$I_D = 250\mu\text{A}, V_{GS} = 0\text{V}$	100	-	-	V
I_{DSS}	Zero Gate Voltage Drain Current	$V_{DS} = 100\text{V}, V_{GS} = 0\text{V}$	-	-	1.0	μA
I_{GSS}	Gate-Body Leakage Current	$V_{DS} = 0\text{V}, V_{GS} = \pm 20\text{V}$	-	-	± 100	nA
On Characteristics						
$V_{GS(th)}$	Gate Threshold Voltage	$V_{DS} = V_{GS}, I_D = 250\mu\text{A}$	1.0	1.5	2.2	V
$R_{DS(ON)}$	Static Drain-Source ON-Resistance ⁽⁴⁾	$V_{GS} = 10\text{V}, I_D = 10\text{A}$	-	34	48	$\text{m}\Omega$
		$V_{GS} = 4.5\text{V}, I_D = 6\text{A}$	-	36	55	$\text{m}\Omega$
Dynamic Characteristics						
R_g	Gate Resistance	$f = 1\text{MHz}$	-	1.8	-	Ω
C_{iss}	Input Capacitance	$V_{GS} = 0\text{V}, V_{DS} = 50\text{V}, f = 1\text{MHz}$	1261	1766	2384	pF
C_{oss}	Output Capacitance		45	63	85	pF
C_{rss}	Reverse Transfer Capacitance		39	55	74	pF
Q_g	Total Gate Charge	$V_{GS} = 0 \text{ to } 10\text{V}$ $V_{DS} = 50\text{V}, I_D = 20\text{A}$	31	44	59	nC
Q_{gs}	Gate Source Charge		5	6	9	nC
Q_{gd}	Gate Drain ("Miller") Charge		8	12	16	nC
Switching Characteristics						
$t_{d(on)}$	Turn-On Delay Time	$V_{GS} = 10\text{V}, V_{DD} = 50\text{V}$ $I_D = 20\text{A}, R_{GEN} = 3\Omega$	-	8	-	ns
t_r	Turn-On Rise Time		-	19	-	ns
$t_{d(off)}$	Turn-Off Delay Time		-	39	-	ns
t_f	Turn-Off Fall Time		-	8	-	ns
Body Diode Characteristics						
I_S	Maximum Continuous Body Diode Forward Current		-	-	20	A
I_{SM}	Maximum Pulsed Body Diode Forward Current		-	-	81	A
V_{SD}	Body Diode Forward Voltage	$V_{GS} = 0\text{V}, I_S = 10\text{A}$	-		1.2	V
t_{rr}	Body Diode Reverse Recovery Time	$I_F = 20\text{A}, di/dt = 100\text{A}/\mu\text{s}$	19	26	36	ns
Q_{rr}	Body Diode Reverse Recovery Charge		-	39.0	-	nC

- Notes:
1. Repetitive Rating: Pulse Width Limited by Maximum Junction Temperature.
 2. E_{AS} condition: Starting $T_J = 25^\circ\text{C}$, $V_{DD} = 50\text{V}$, $V_G = 10\text{V}$, $R_G = 25\text{ohm}$, $L = 0.5\text{mH}$, $I_{AS} = 11.34\text{A}$, $V_{DD} = 0\text{V}$ during time in avalanche.
 3. $R_{\theta JA}$ is measured with the device mounted on a 1inch^2 pad of 2oz copper FR4 PCB.
 4. Pulse Test: Pulse Width $\leq 300\mu\text{s}$, Duty Cycle $\leq 0.5\%$.

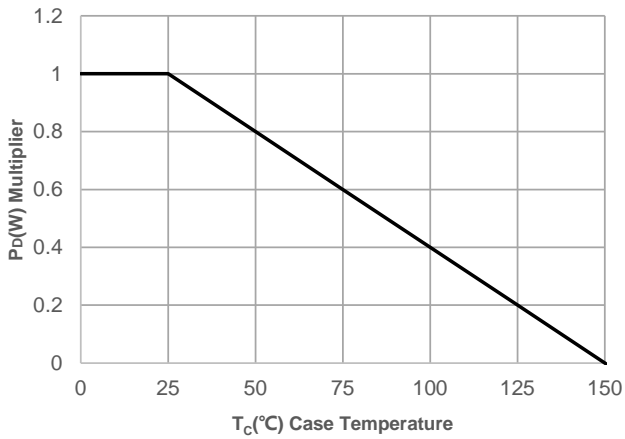
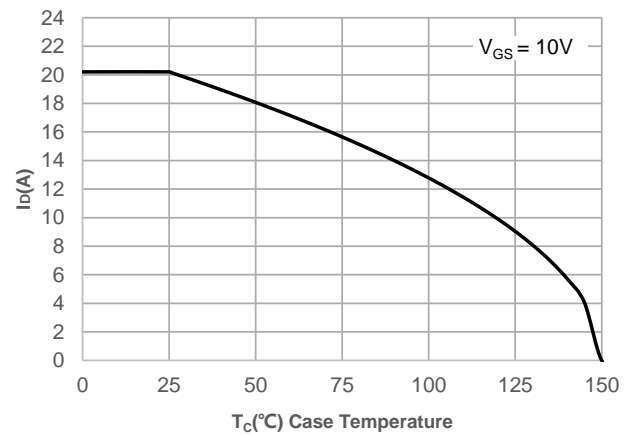
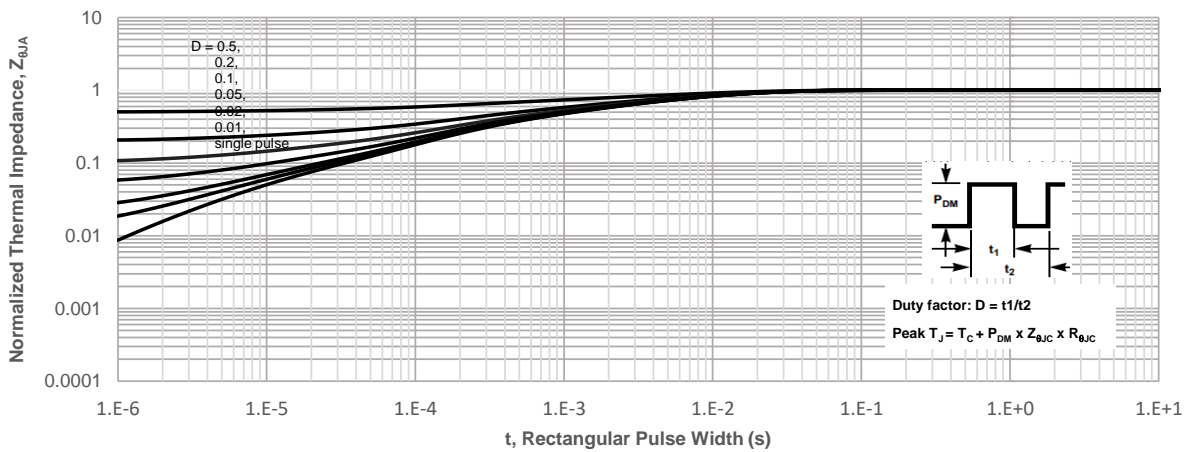
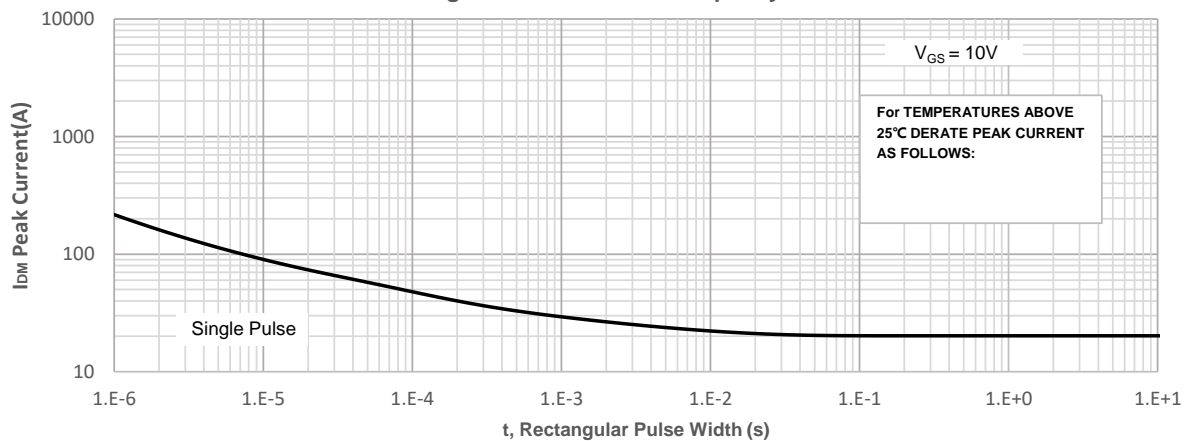

Typical Performance Characteristics

Figure 1: Power De-rating

Figure 2: Current De-rating

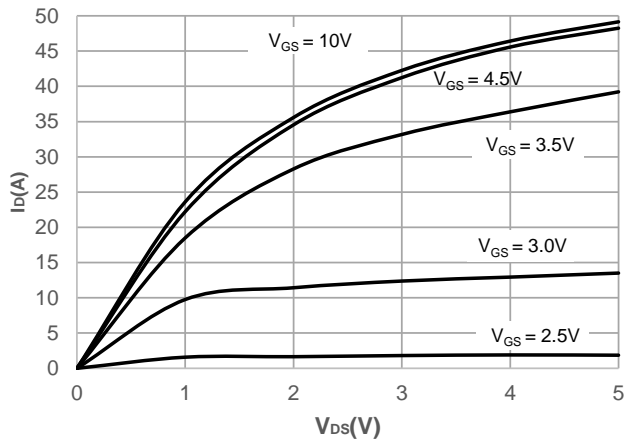
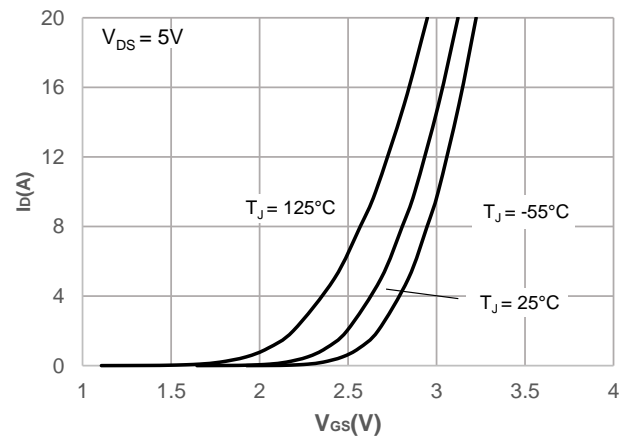
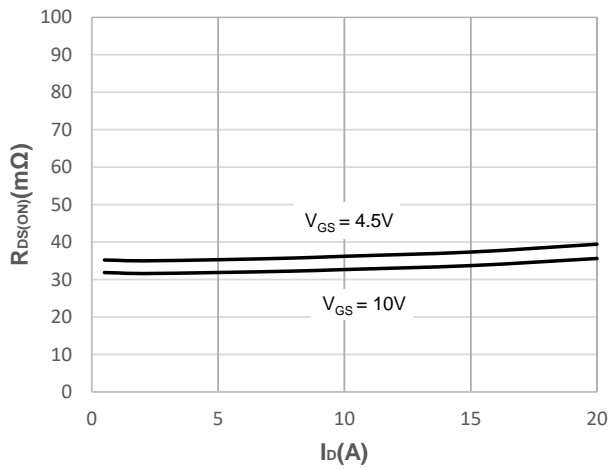
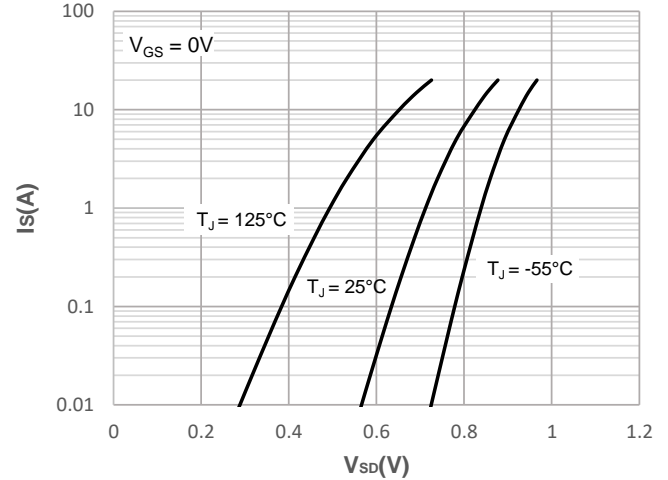
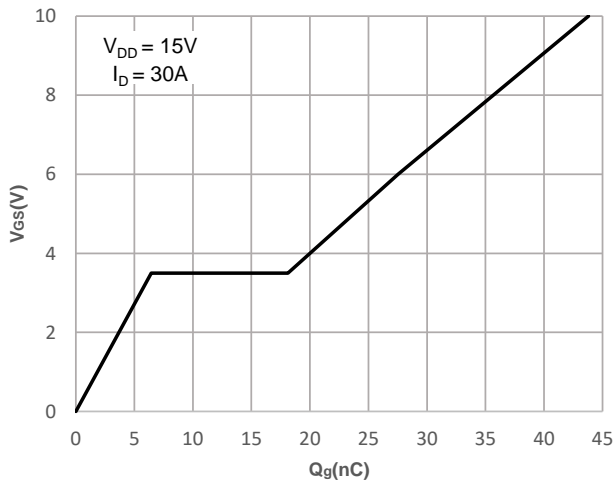
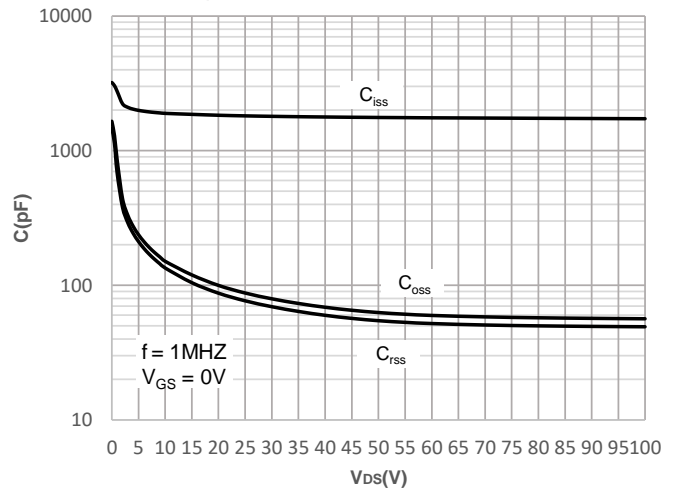
Figure 3: Normalized Maximum Transient Thermal Impedance

Figure 4: Peak Current Capacity

Typical Performance Characteristics

Figure 5: Output Characteristics

Figure 6: Typical Transfer Characteristics

Figure 7: On-resistance vs. Drain Current

Figure 8: Body Diode Characteristics

Figure 9: Gate Charge Characteristics

Figure 10: Capacitance Characteristics

Typical Performance Characteristics

Figure 11: Normalized Breakdown voltage vs. Junction Temperature

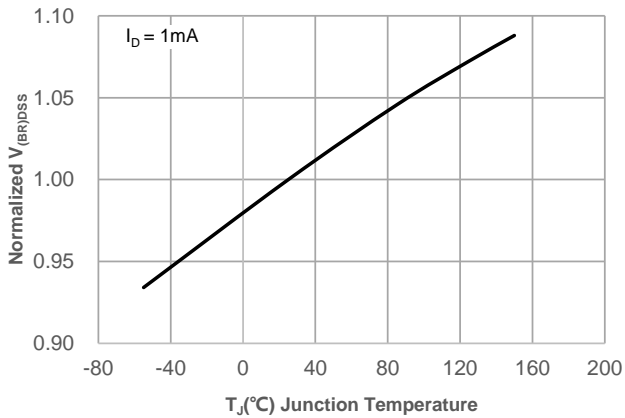

Figure 12: Normalized on Resistance vs. Junction Temperature

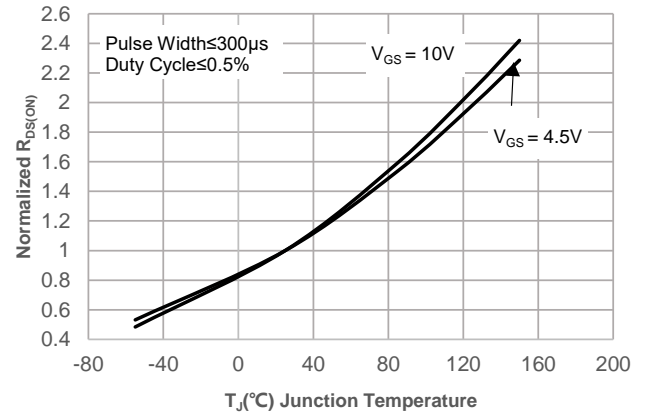

Figure 13: Normalized Threshold Voltage vs. Junction Temperature

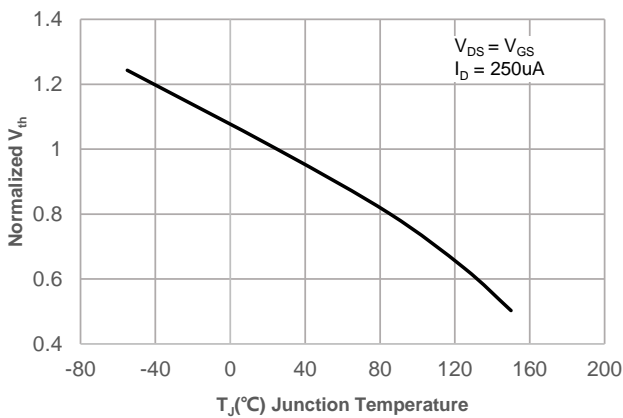

Figure 14: $R_{DS(ON)}$ vs. V_{GS}

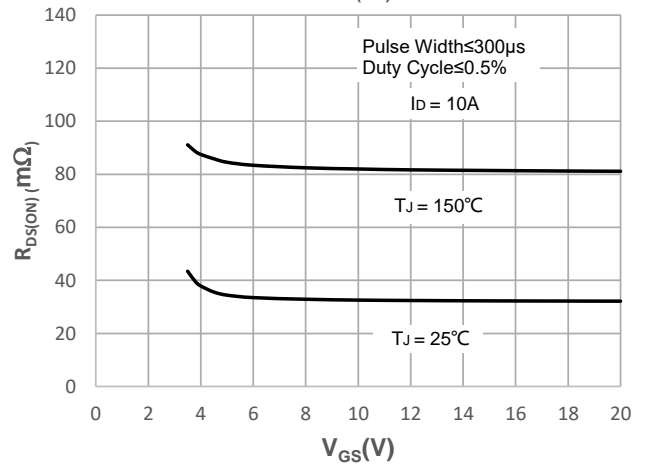
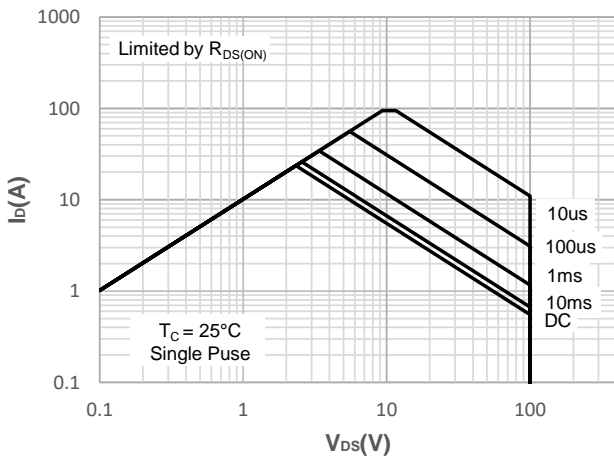
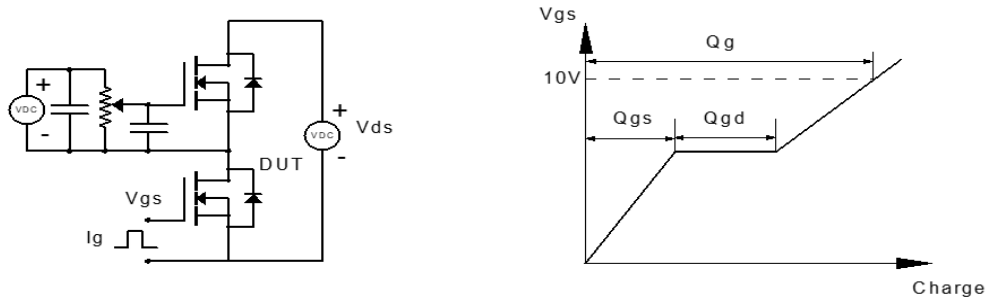
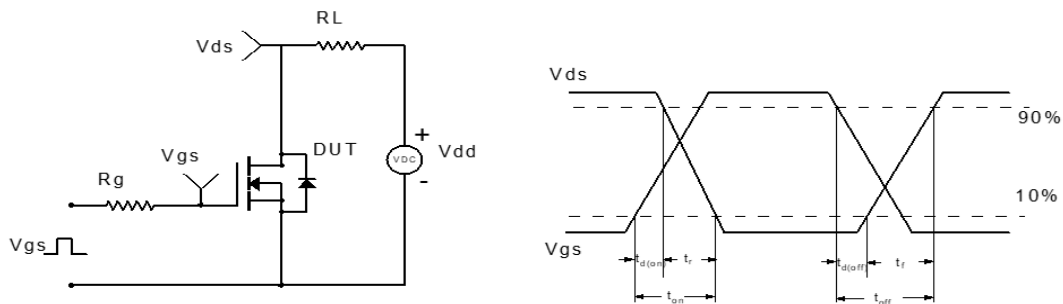
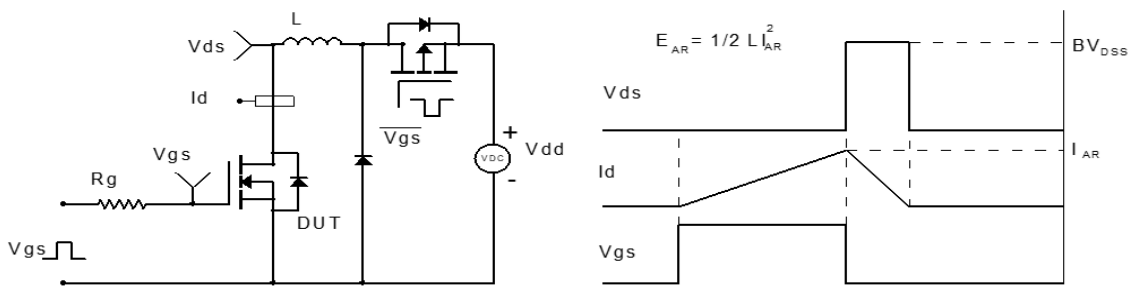
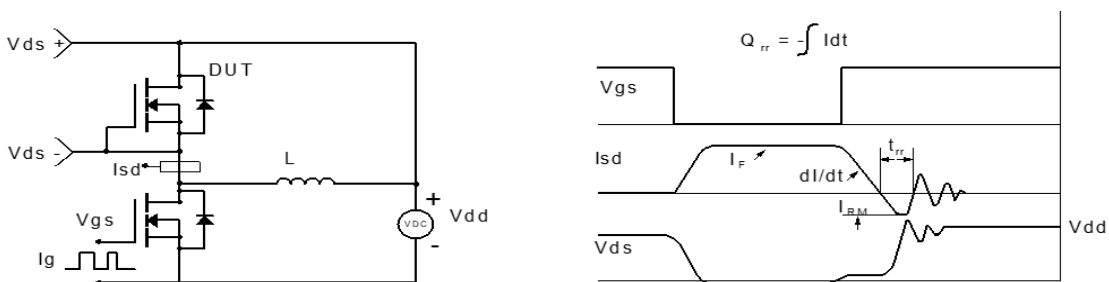
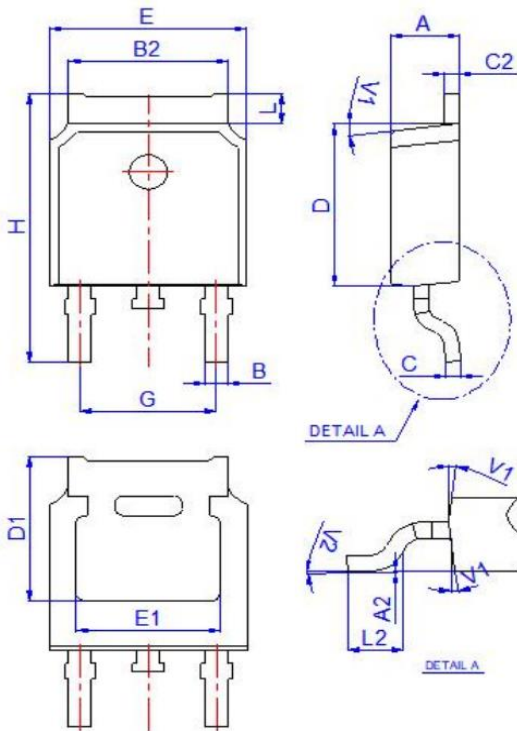

Figure 15: Maximum Safe Operating Area



Test Circuit

Figure 1: Gate Charge Test Circuit & Waveform

Figure 2: Resistive Switching Test Circuit & Waveform

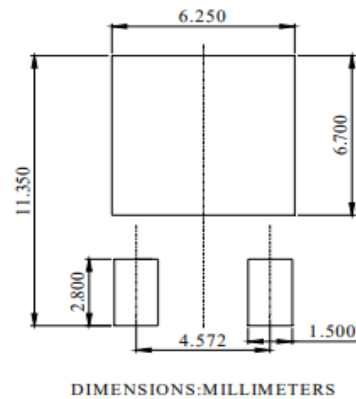
Figure 3: Unclamped Inductive Switching Test Circuit & Waveform

Figure 4: Diode Recovery Test Circuit & Waveform

Package Mechanical Data(TO-252-3L)

Ref.	Dimensions					
	Millimeters			Inches		
	Min.	Typ.	Max.	Min.	Typ.	Max.
A	2.10		2.50	0.083		0.098
A2	0		0.10	0		0.004
B	0.66		0.86	0.026		0.034
B2	5.18		5.48	0.202		0.216
C	0.40		0.60	0.016		0.024
C2	0.44		0.58	0.017		0.023
D	5.90		6.30	0.232		0.248
D1	5.30REF			0.209REF		
E	6.40		6.80	0.252		0.268
E1	4.63			0.182		
G	4.47		4.67	0.176		0.184
H	9.50		10.70	0.374		0.421
L	1.09		1.21	0.043		0.048
L2	1.35		1.65	0.053		0.065
V1		7°			7°	
V2	0°		6°	0°		6°

Recommended Soldering Footprint

Information furnished in this document is believed to be accurate and reliable. However, Jiangsu JieJie Microelectronics Co.,Ltd assumes no responsibility for the consequences of use without consideration for such information nor use beyond it. Information mentioned in this document is subject to change without notice, apart from that when an agreement is signed, Jiangsu JieJie complies with the agreement. Products and information provided in this document have no infringement of patents. Jiangsu JieJie assumes no responsibility for any infringement of other rights of third parties which may result from the use of such products and information.



is a registered trademark of Jiangsu JieJie Microelectronics Co.,Ltd.

